

**Installazione:** a incasso in cartongesso

**Ambiente utilizzo:** interni

**Utilizzo tipico:** Uffici , residenziale, hotel , musei , ristoranti , negozi, sale riunioni aree comuni, scuole

## OTTICHE

**Emissione luminosa:** diffusa down

**Flusso Luminoso:** 3'360lm

**Tonalità:** 3'000K (2'700K o 4'000K su richiesta)

**Sorgente luminosa:** Led SMD >140lm/w C.R.I.>90

**Vita nominale prodotto:** 50'000h L80B20 (Ta 25°C)

## ELETTRICHE

**Potenza:** 30W

**Tensione:** 220VAC

**Alimentatore:** incluso

## FISICHE

**Dimensioni:** L 58+58cm sezione H6,5 X 3,15cm

**Temperatura operativa:** -10 / +35°C

**Materiali:** struttura: Metallo  
diffusore: pmma PRISM

**Peso:** 2 kg

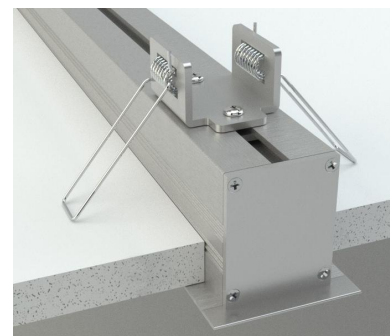

**MINISIMPLY SYSTEM incasso cartongesso con cornice L58+58cm**  
designed by TI Lighting LAB

Lampada angolare L58+58cm ad incasso in cartongesso con cornice.  
Sorgente luminosa a LED.  
Emissione luminosa DIFFUSA DOWN

BV Bianco verniciato

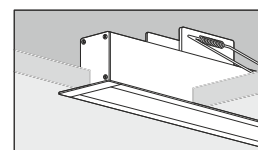
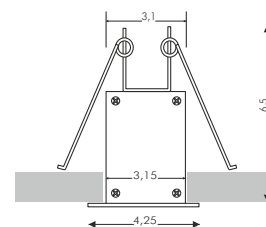
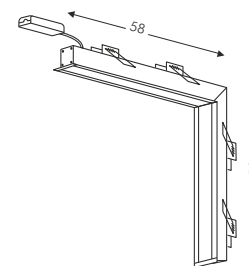

## CERTIFICAZIONI

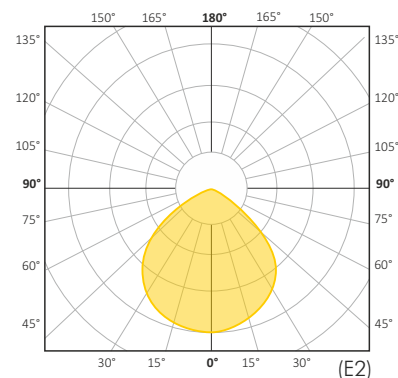

## VARIAZIONI

## TAGLIO DI FASE

Codice:  4024T1DM**MINISIMPLY SYSTEM** incasso cartongesso  
con cornice L58+58cm

designed by TI Lighting LAB

Lampada angolare L58+58cm ad incasso  
in cartongesso con cornice.

Sorgente luminosa a LED.

Emissione luminosa DIFFUSA DOWN

	BV	Bianco verniciato
---	----	-------------------

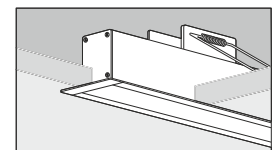
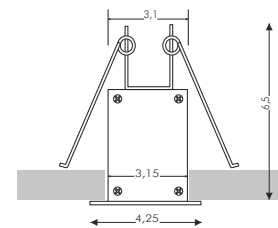
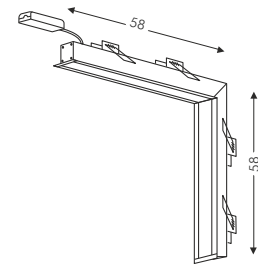

## CERTIFICAZIONI

