

- 1) Forare il cartongesso
- 1) Drilling plasterboard

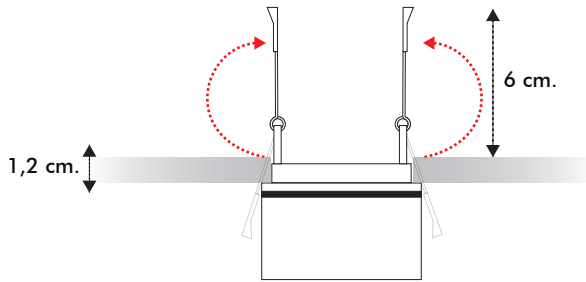
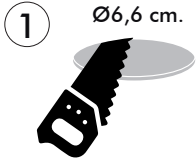

DRIVERS:

OF=ON/OFF Driver

TF=TRIAC Driver

DM=DALI Driver

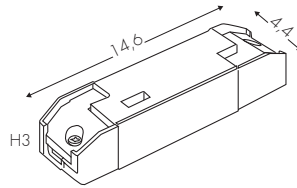
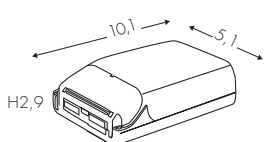
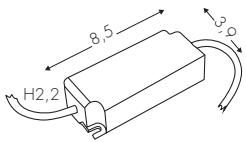

- 2) Effettuare il collegamento elettrico
- 2) Making the electrical connection



2

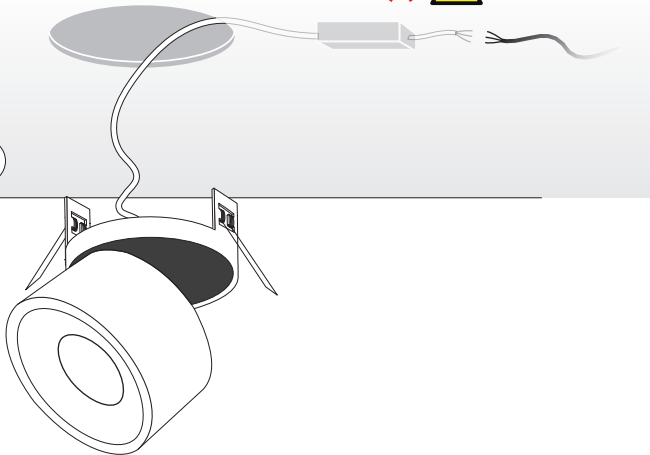

- 3) Inserire il prodotto nel cartongesso sollevando le molle
- 3) Insert the product into the plasterboard by lifting the springs

3

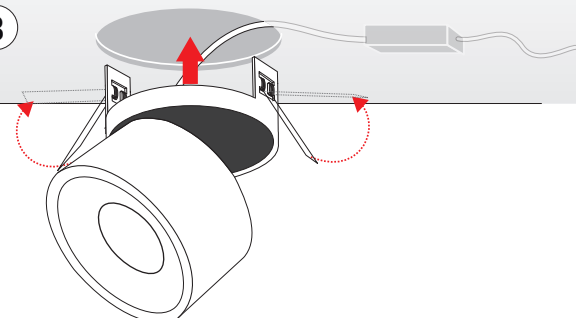

MOVE

Incasso / Recessed

4094A

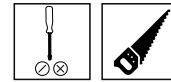

Togliere la rete di alimentazione prima dell'installazione, sostituzione della lampada e comunque prima di ogni operazione di manutenzione.

Always turn off power supply before install, replacing of the light bulb and prior to any maintenance interventions.



La sicurezza dell'apparecchio è garantita solo con l'uso appropriato delle seguenti istruzioni; pertanto è necessario consultarle e conservarle.

The safety of this product is guaranteed only if correctly used, according to this instruction sheet, which must be read first

COLLEGAMENTO ELETTRICO * ELECTRICAL CONNECTION



Attenzione! Togliere la rete di alimentazione prima dell'installazione, sostituzione della lampada e comunque prima di ogni operazione di manutenzione.

Caution! Always turn off power supply before install, replacing of the light bulb and prior to any maintenance interventions.

ON/OFF

Versione ONOFF
ONOFF Version

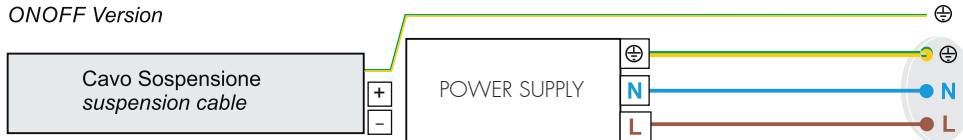

DM

Versione dimmerabile - Collegamento con pulsante
Dimmable Version - Touch-DIM wiring

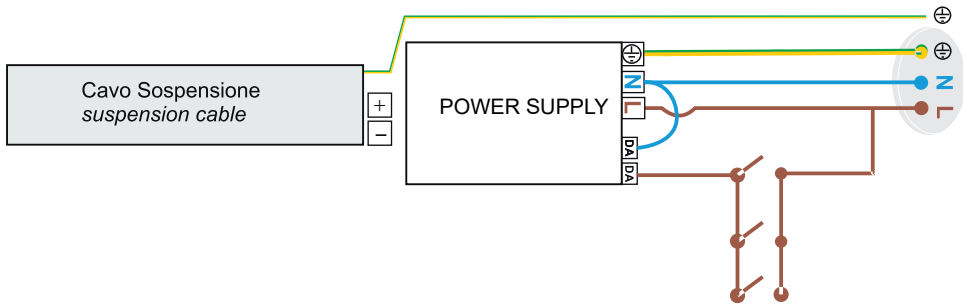

Touch-DIM

DM

Versione dimmerabile - Collegamento con sistema di gestione
Dimmable Version - Management System wiring

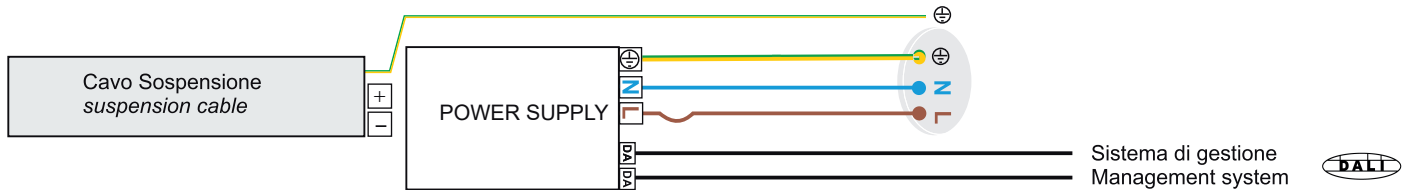

TF

Versione TAGLIO DI FASE

